



HS359800-1

Key Features

- Patented *Crimped Fin*® Technology
- Intel Approved Heat Sink
- High Density Fin Array
- No Solder Process
- 100% Lead-free Components
- Mounting Hardware and TIM Included

Thermal Performance

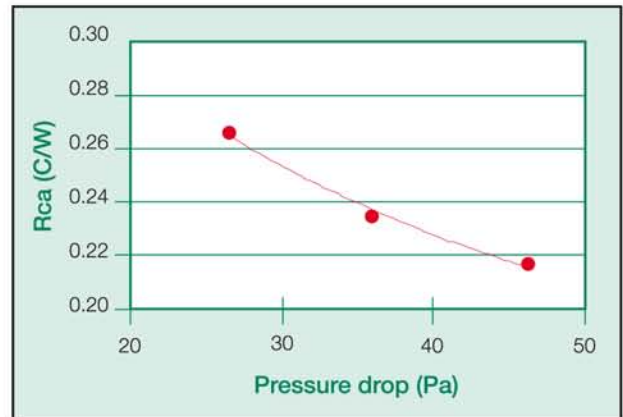
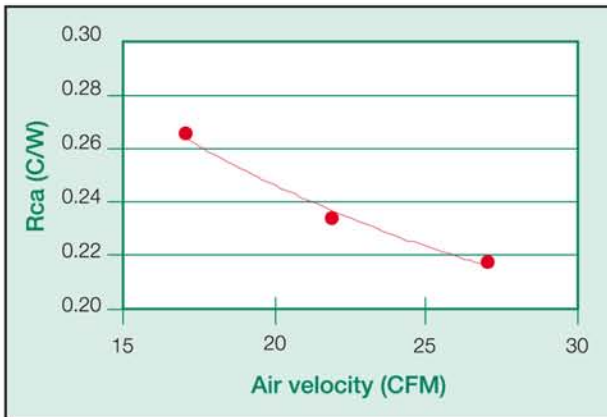

Mechanical Specifications

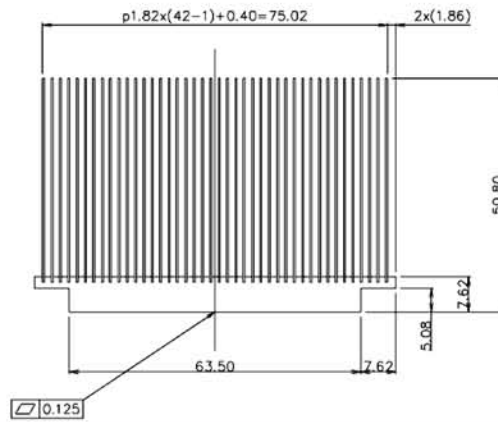
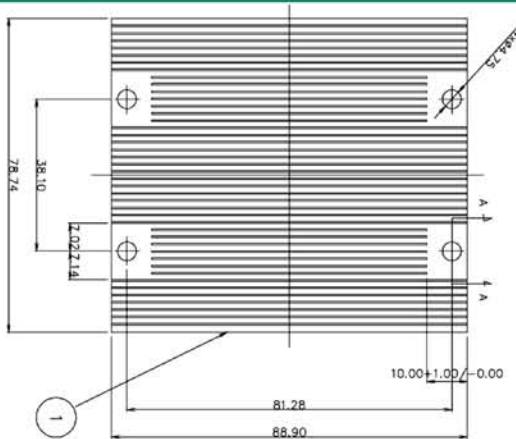

Physical Specifications

- Material: Cu Base/Cu Fins
- Weight: 940 grams
- Interface Material: Honeywell PCM45F
- Socket: CEK604